

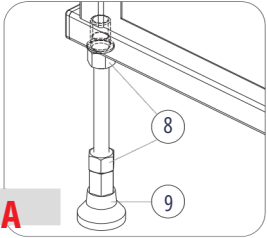

# СХЕМА СБОРКИ ОТДЕЛЬНЫХ УЗЛОВ КАРКАСА ВАНН

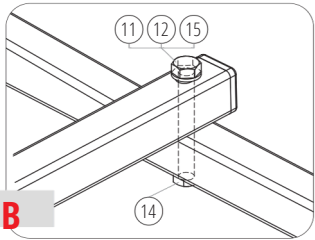

**A**



**B**

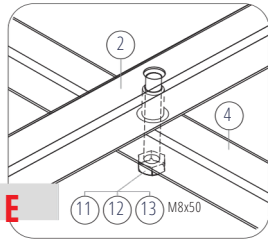

**E**

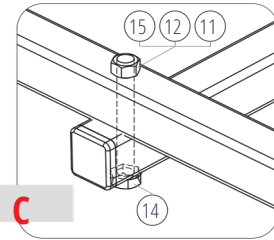

**C**

! продольный профиль 2 крепится к опорному профилю 3 снизу

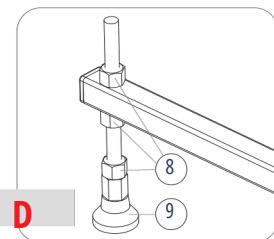
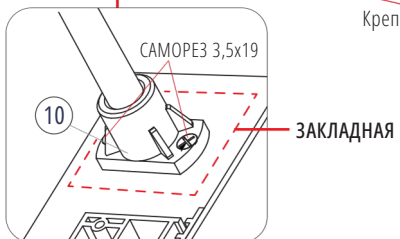
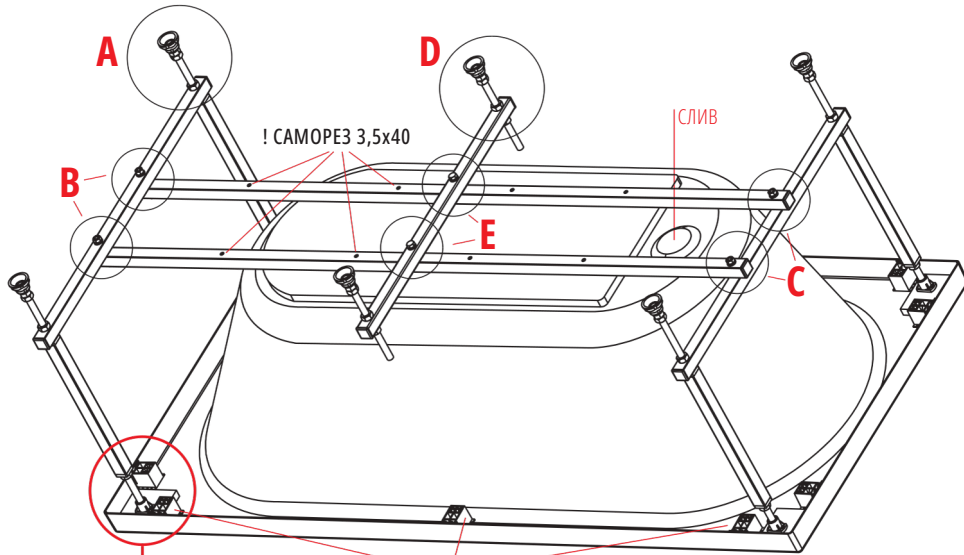

**D**

# СТАНДАРТНЫЙ КАРКАС ДЛЯ ВАНН

